

VersaFlap dual 2.0

Modulo cablato integrato a scomparsa
Built-in power/data module

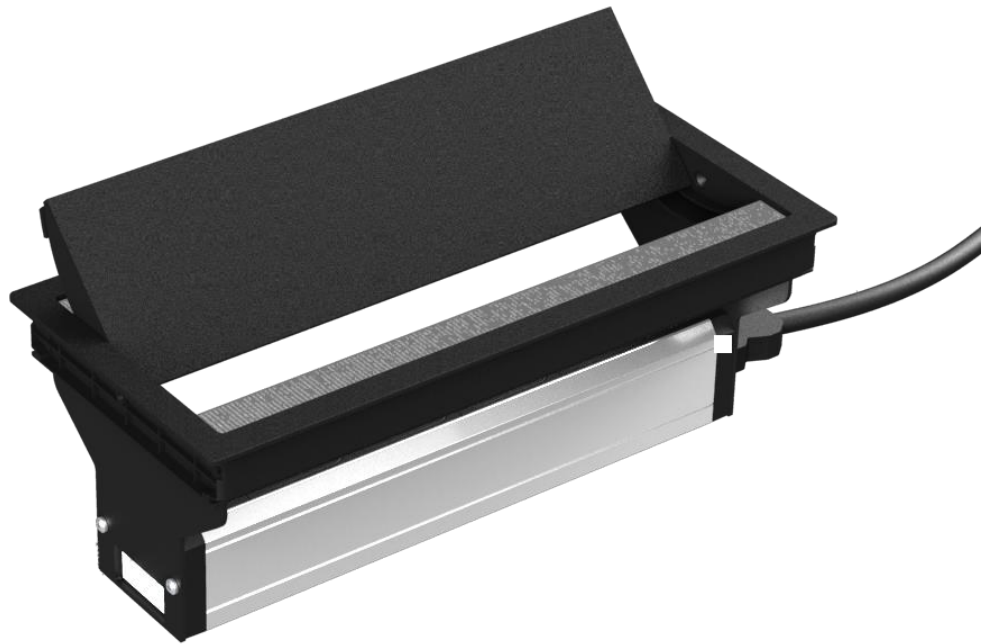

Dati commerciali / Commercial data

Codice prodotto/Product code: 06011

N° Disegno/ Drawing N°:

Dati tecnici/Technical data

Generale/General

Tensione nominale <i>Rated voltage</i>	110 - 250 V ac, 50/60 Hz	
Corrente nominale <i>Rated current</i>	10 - 16A	
Carico massimo complessivo <i>Max.load power</i>	3400W	Per prese tipo / <i>For sockets type</i> : E - F - K - L - UNEL
	2800W	Per prese tipo / <i>For sockets type</i> : G
	2200W	Per prese tipo / <i>For sockets type</i> : I - J
	1200W	Per prese tipo / <i>For sockets type</i> : B
Grado di protezione <i>Degree of protection</i>	IP20	
Ambiente di utilizzo <i>Operating environment</i>	Interno <i>Indoor</i>	

SCHEMA TECNICA/ DATA SHEET

ED.03 10.06.2021

Materiali/Materials

Profilo e cornice <i>Profile and frame</i>	Alluminio <i>Aluminium</i>
Componenti assemblaggio <i>Assembly parts</i>	Tecnopolimero autoestinguente <i>Flame retardant polymer</i>
Prese elettriche <i>Electric Sockets</i>	Tecnopolimero autoestinguente <i>Flame retardant polymer</i>

Prese elettriche/ Electric sockets

Tipo <i>Type</i>	B - E - F - G - I - J - K - L - UNEL, 2P+T, con otturatori (protezione bimbi) <i>B - E - F - G - I - J - K - L - UNEL, 2P+T, with shutters (child protection)</i>	
		
Voltaggio <i>Rated voltage</i>	220 - 250 V ac 50 Hz	Presca tipo/ <i>Socket type</i> : E - F - G - I - J - K - L - UNEL
	110 - 125 V ac 60 Hz	Presca tipo/ <i>Socket type</i> : B
	16 A	Presca tipo/ <i>Socket type</i> : E - F - K - L - UNEL
Corrente <i>Rated current</i>	15 A	Presca tipo/ <i>Socket type</i> : B
	13 A	Presca tipo/ <i>Socket type</i> : G
	10 A	Presca tipo/ <i>Socket type</i> : I - J





Porte USB da ricarica / USB Charging ports

Ingresso: <i>Input:</i>	Ingresso tensione AC: <i>Input AC voltage:</i>	100 - 250 V ac 50/60 Hz
	Uscita DC - porta USB <i>Output DC - USB port</i>	5V – 2.1A
Uscita: <i>Output:</i>	Potenza totale <i>Total output power</i>	10.5 W
	Tipo connettore USB <i>USB connector type</i>	Tipo A femmina <i>Type A female</i>
Compatibilità <i>Compatibility</i>	Tutti smartphone, tablet e dispositivi ricaricabili (fotocamere, auricolari, ecc.) <i>All smartphones, tablets and USB chargeable devices (cameras, headset etc.)</i>	

Connettori dati-voce / Data-voice connectors

LAN/Ethernet	RJ45 CAT.6 UTP / RJ45 CAT.6A STP <i>RJ45 CAT.6 UTP / RJ45 CAT.6A STP</i>
USB	USB 2.0 <i>USB 2.0</i>
Video	VGA (15-pin) <i>VGA (15-pin)</i>
Audio	Mini-jack 3.5 mm <i>Mini-jack 3.5 mm</i>
Audio/Video	HDMI DisplayPort

Finiture / Finishes

Corpo <i>Body</i>	Nero <i>Black</i>	
	Bianco <i>White</i>	
	Grigio <i>Grey</i>	
Spazzola <i>Brush</i>	Nera <i>Black</i>	
	Grigio <i>Grey</i>	

Certificazioni / Approvals



Note/Notes

- Personalizzabile per tipo di prese e connettori data
- Disponibili a richiesta altre finiture
- Uso solo in ambienti interni



ATTENZIONE!!!

- Questo apparecchio deve essere collegato a terra
- L'apparecchio deve essere collegato ad una presa principale correttamente installata e provvista di collegamento a terra in accordo alle norme vigenti.
- Se il prodotto viene montato in zone a rischio di contatto con l'acqua, bisogna applicare del silicone o sigillanti similari sul piano dove appoggia la cornice.

- *It can be customized according to the type of sockets and data connectors*
- *Indoor use only*
- *Other finishes available upon request*



WARNING!!!

- *This appliance must be earthed*
- *This appliance must be connected to a main socket correctly installed and provided with ground connection in accordance with current norms.*
- *If the product is mounted in areas at risk of contact with water, it is necessary to apply silicone or similar sealants on the panel where the frame stands.*



Tutte le dimensioni indicate sono nominali. I disegni e le immagini sono solo a scopo illustrativo. I dettagli del prodotto e le dimensioni sono soggetti a modifiche senza preavviso.



All dimensions quoted are nominal only. Drawings and images are for illustrative purposes only. All product dimensions and specifications are subject to change without notice.

Dimensioni/Dimensions

VERSIONI VERSIONS VERSIONEN VERSIONS	A	B	L
1	304.5	140.5	316
2	437	140.5	448

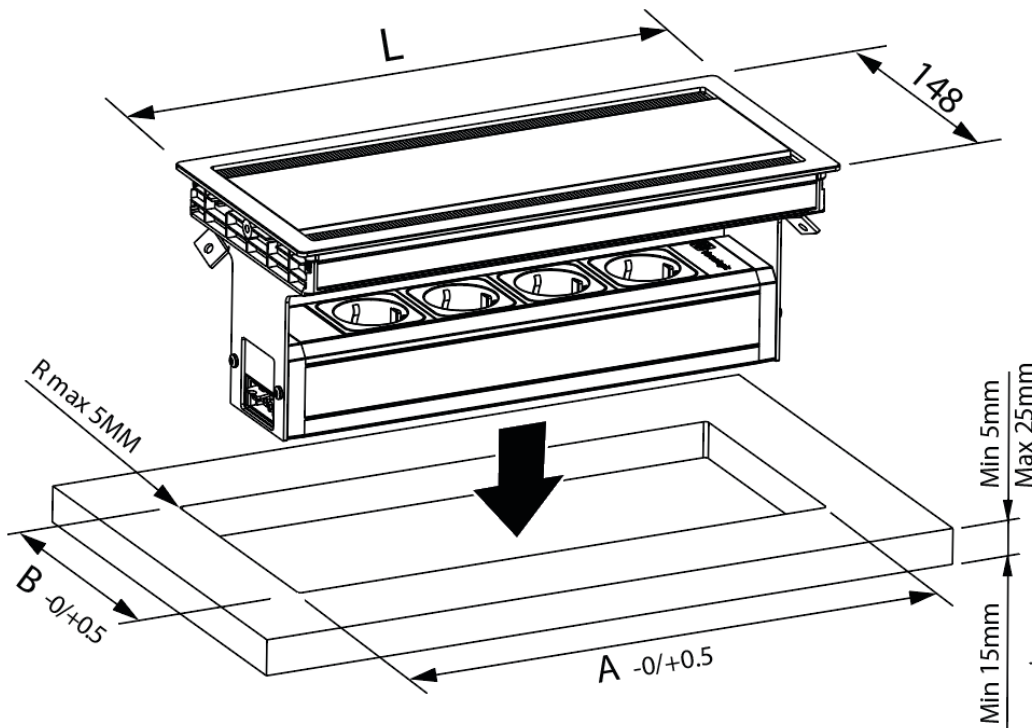
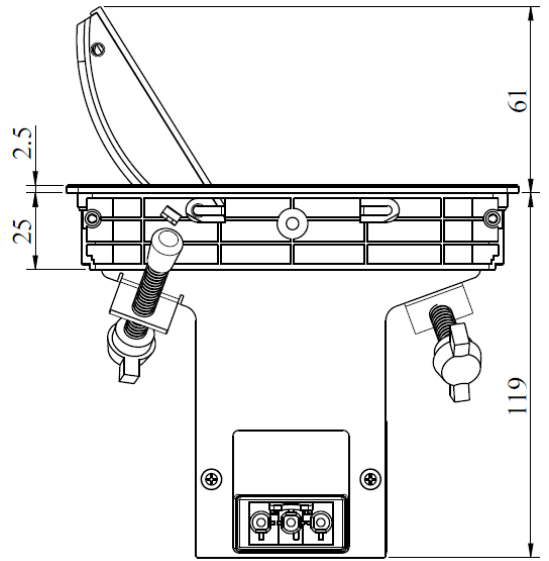



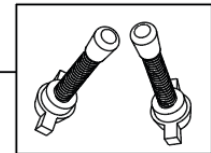



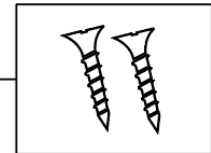

OPTION 1



OPTION 2





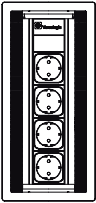
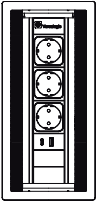
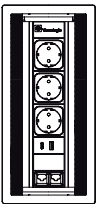
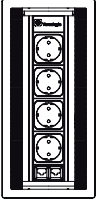













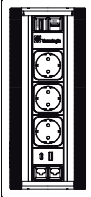
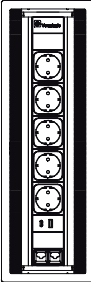
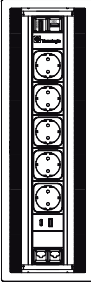



*VITI NON FORNITE
*SCREWS NOT PROVIDED
*NICHT MITGELIEFERTE SCHRAUBEN
*VIS NON FOURNIES

Versaflap dual 2.0						
PRESA SOCKET		 	 	 	 	
		U (UNEL)	F (SCHUKO)	E (FRENCH)	G (UK)	
		4 FRUTTI POWER 4 POWER SOCKETS				
CODICE CODE	alluminio aluminum	060.38U.00001	060.38F.00001	060.38E.00001	060.38G.00001	 L = 316 mm
	PREZZO PRICE					
	bianco white	060.38U.00002	060.38F.00002	060.38E.00003	060.38G.00002	
	PREZZO PRICE					
	nero black	060.38U.00003	060.38F.00003	060.38E.00003	060.38G.00003	
	PREZZO PRICE					
	acciaio spazzolato stainless steel	060.38U.00004	060.38F.00004	060.38E.00004	060.38G.00004	
PREZZO PRICE						
		3 FRUTTI POWER + 1 USB 5V (A+C) 3 POWER SOCKETS + 1 USB 5V (A+C)				
CODICE CODE	alluminio aluminum	060.38U.00005	060.38F.00005	060.38E.00005	060.38G.00005	 L = 316 mm
	PREZZO PRICE					
	bianco white	060.38U.00006	060.38F.00006	060.38E.00006	060.38G.00006	
	PREZZO PRICE					
	nero black	060.38U.00007	060.38F.00007	060.38E.00007	060.38G.00007	
	PREZZO PRICE					
	acciaio spazzolato stainless steel	060.38U.00008	060.38F.00008	060.38E.00008	060.38G.00008	
PREZZO PRICE						
		3 FRUTTI POWER + 1 USB 5V (A+C) + 2RJ45 cat 6 STP 3 POWER SOCKETS + 1 USB 5V (A+C) + 2RJ45 cat 6 STP				
CODICE CODE	alluminio aluminum	060.38U.00009	060.38F.00009	060.38E.00009	060.38G.00009	 L = 316 mm
	PREZZO PRICE					
	bianco white	060.38U.00010	060.38F.00010	060.38E.00010	060.38G.00010	
	PREZZO PRICE					
	nero black	060.38U.00011	060.38F.00011	060.38E.00011	060.38G.00011	
	PREZZO PRICE					
	acciaio spazzolato stainless steel	060.38U.00012	060.38F.00012	060.38E.00012	060.38G.00012	
PREZZO PRICE						
		4 FRUTTI POWER + 2RJ45 cat 6 STP 4 POWER SOCKETS + 2RJ45 cat 6 STP				
CODICE CODE	alluminio aluminum	060.38U.00013	060.38F.00013	060.38E.00013	060.38G.00013	 L = 316 mm
	PREZZO PRICE					
	bianco white	060.38U.00014	060.38F.00014	060.38E.00014	060.38G.00014	
	PREZZO PRICE					
	nero black	060.38U.00015	060.38F.00015	060.38E.00015	060.38G.00015	
	PREZZO PRICE					
	acciaio spazzolato stainless steel	060.38U.00016	060.38F.00016	060.38E.00016	060.38G.00016	
PREZZO PRICE						

versafiap dual 2.0

Versaflap dual 2.0

PRESA SOCKET		  U (UNEL)	  F (SCHUKO)	  E (FRENCH)	  G (UK)	
		3 FRUTTI POWER +1 USB 5V (A+C) + 2RJ45 CAT6 FTP + 1 HDMI + 1USB dati 3 POWER SOCKETS +1 USB 5V (A+C) + 2RJ45 CAT6 FTP + 1USB data				 L = 316 mm
CODICE CODE	alluminio aluminum	060.38U.00017	060.38F.00017	060.38E.00017	060.38G.00017	
	PREZZO PRICE		€ 266,00			
	bianco white	060.38U.00018	060.38F.00018	060.38E.00018	060.38G.00018	
	PREZZO PRICE					
	nero black	060.38U.00019	060.38F.00019	060.38E.00019	060.38G.00015	
	PREZZO PRICE					
	acciaio spazzolato stainless steel	060.38U.00020	060.38F.00020	060.38E.00020	060.38G.00016	
	PREZZO PRICE					
		5 FRUTTI POWER + 1 USB 5V (A+C) + 2RJ45 cat6 STP 5 POWER SOCKETS + 1 USB 5V (A+C) + 2RJ45 cat6 STP				 L = 448 mm
CODICE CODE	alluminio aluminum	060.38U.00021	060.38F.00021	060.38E.00021	060.38G.00021	
	PREZZO PRICE					
	bianco white	060.38U.00022	060.38F.00022	060.38E.00022	060.38G.00022	
	PREZZO PRICE					
	nero black	060.38U.00023	060.38F.00023	060.38E.00023	060.38G.00023	
	PREZZO PRICE					
	acciaio spazzolato stainless steel	060.38U.00024	060.38F.00024	060.38E.00024	060.38G.00024	
	PREZZO PRICE					
		5 FRUTTI POWER +1 USB 5V (A+C) + 2RJ45 CAT6 FTP + 1 HDMI + 1USB dati 5 POWER SOCKETS +1 USB 5V (A+C) + 2RJ45 CAT6 FTP + 1USB data				 L = 448 mm
CODICE CODE	alluminio aluminum	060.38U.00025	060.38F.00025	060.38E.00025	060.38G.00025	
	PREZZO PRICE					
	bianco white	060.38U.00026	060.38F.00026	060.38E.00026	060.38G.00026	
	PREZZO PRICE					
	nero black	060.38U.00027	060.38F.00027	060.38E.00027	060.38G.00027	
	PREZZO PRICE					
	acciaio spazzolato stainless steel	060.38U.00028	060.38F.00028	060.38E.00028	060.38G.00028	
	PREZZO PRICE					
NOTE NOTES						
DIM. L x H x W -		PEZZI PER SCATOLA PCS PER BOX 1	MOQ 4 PZ / PCS	CODICE DOGANALE CUSTOM CODE 85366990		
CAVI INCLUSI CABLES INCLUDED -	 					

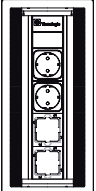
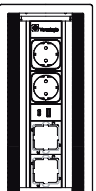
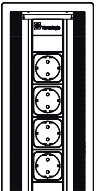
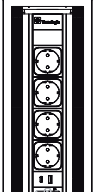
VERSAFLAP DUAL 2.0 PRO						
PRESA SOCKET		  U (JUNEL)	  F (SCHUKO)	  E (FRENCH)	  G (UK)	
versapro		2 FRUTTI POWER + 2 TUNNEL 2 POWER SOCKETS + 2 TUNNEL				 L = 316 mm
CODICE CODE	alluminio aluminum	061.38U.00001	061.38F.00001	061.38E.00001	061.38G.00001	
	PREZZO PRICE					
	bianco white	061.38U.00002	061.38F.00002	061.38E.00002	061.38G.00002	
	PREZZO PRICE					
	nero black	061.38U.00003	061.38F.00003	061.38E.00003	061.38G.00003	
	PREZZO PRICE					
	acciaio spazzolato stainless steel	061.38U.00004	061.38F.00004	061.38E.00004	061.38G.00004	
	PREZZO PRICE					
versapro		2 FRUTTI POWER + 1 USB 5V (A+C) + 2 TUNNEL 2 POWER SOCKETS + 1 USB 5V (A+C) + 2 TUNNEL				 L = 316 mm
CODICE CODE	alluminio aluminum	061.38U.00005	061.38F.00005	061.38E.00005	061.38G.00005	
	PREZZO PRICE					
	bianco white	061.38U.00006	061.38F.00006	061.38E.00006	061.38G.00006	
	PREZZO PRICE					
	nero black	061.38U.00007	061.38F.00007	061.38E.00007	061.38G.00007	
	PREZZO PRICE					
	acciaio spazzolato stainless steel	061.38U.00008	061.38F.00008	061.38E.00008	061.38G.00008	
	PREZZO PRICE					
versapro		4 FRUTTI POWER + 2 TUNNEL 4 POWER SOCKETS + 2 TUNNEL				 L = 448 mm
CODICE CODE	alluminio aluminum	061.38U.00009	061.38F.00009	061.38E.00009	061.38G.00009	
	PREZZO PRICE					
	bianco white	061.38U.00010	061.38F.00010	061.38E.00010	061.38G.00010	
	PREZZO PRICE					
	nero black	061.38U.00011	061.38F.00011	061.38E.00011	061.38G.00011	
	PREZZO PRICE					
	acciaio spazzolato stainless steel	061.38U.00012	061.38F.00012	061.38E.00012	061.38G.00012	
	PREZZO PRICE					
versapro		4 FRUTTI POWER + 1 USB 5V (A+C) + 2 TUNNEL 4 POWER SOCKETS + 1 USB 5V (A+C) + 2 TUNNEL				 L = 448 mm
CODICE CODE	alluminio aluminum	061.38U.00013	061.38F.00013	061.38E.00013	061.38G.00013	
	PREZZO PRICE					
	bianco white	061.38U.00014	061.38F.00014	061.38E.00014	061.38G.00014	
	PREZZO PRICE					
	nero black	061.38U.00015	061.38F.00015	061.38E.00015	061.38G.00015	
	PREZZO PRICE					
	acciaio spazzolato stainless steel	061.38U.00016	061.38F.00016	061.38E.00016	061.38G.00016	
	PREZZO PRICE					
NOTE NOTES						
PEZZI PER SCATOLA PCS PER BOX 1			MOQ 4 PZ / PCS			